



MECHANICAL FENCE

MODEL FENCE - FRONT VIEW



About us

Fence Design LLC is a company that works in the field of construction and marketing of metal structures, aimed at businesses and individuals.

We design and manufacture innovative products in the architectural field, with high standards of quality and beauty.

Mision

Our organization is based on offering a full satisfaction experience to each client, understanding the importance of what a product and service of excellence mean.

We are a solid structure that is complemented by constant innovation and that evolves in each project as a human and professional team.

We manufacture and market quality products that are an impressive complement to architectural design and quality of life.

Company

Vision

We are a company that aims at the orderly growth of our capacities.

Always focused on the direction of progress, profitability and common welfare.

th the determination to consolidate ourselves as a leading company in the competitive market.

Values

Quality
Innovation
Customer service
Honesty
Responsibility
synergy

Colors and size

Size height: 4' - 5' - 6' feet

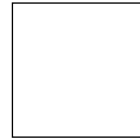
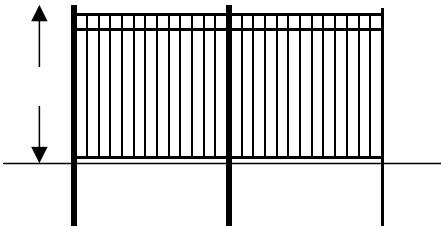

White



Bronze



Black

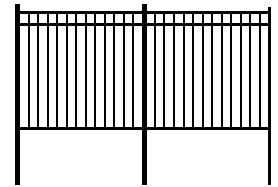
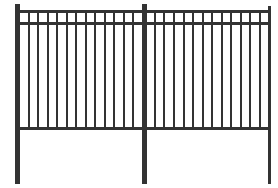
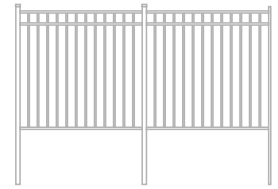

Models

POPOLI

CODE: 1

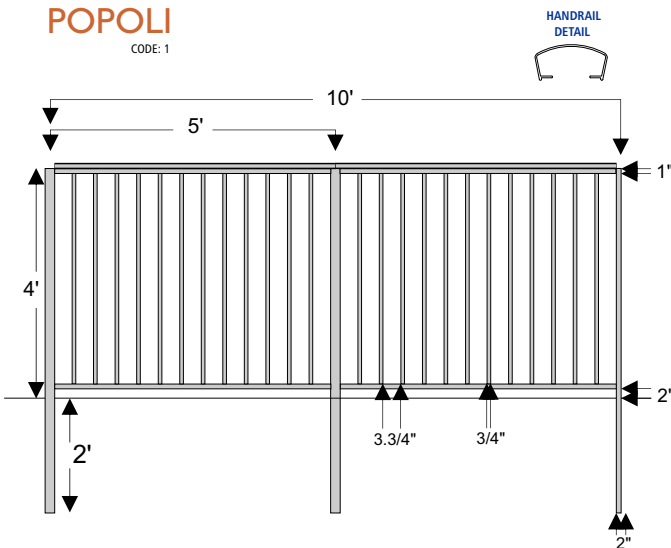

TREVISO

2 rail CODE: 3
3 rail CODE: 3.1

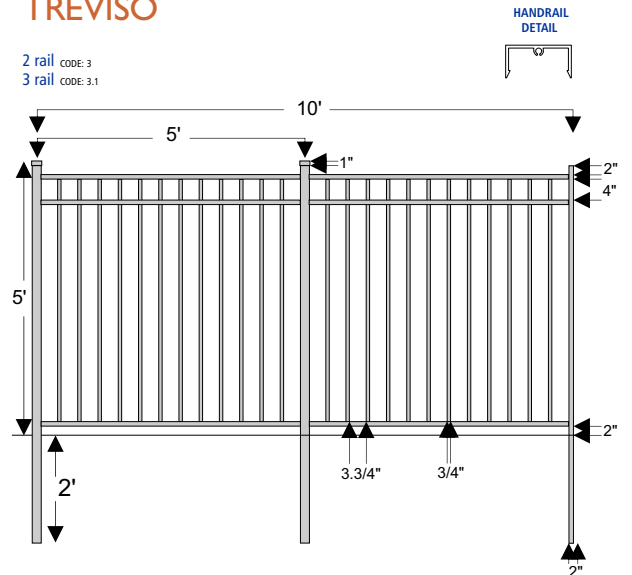

Models

MILANO

2 rail CODE: 9
3 rail CODE: 9.1

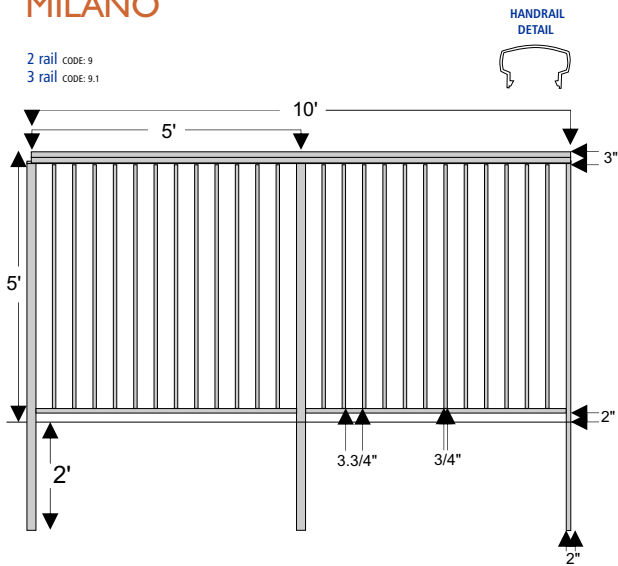

AMALFI

2 rail ball quad CODE: 4
3 rail ball quad CODE: 4.1

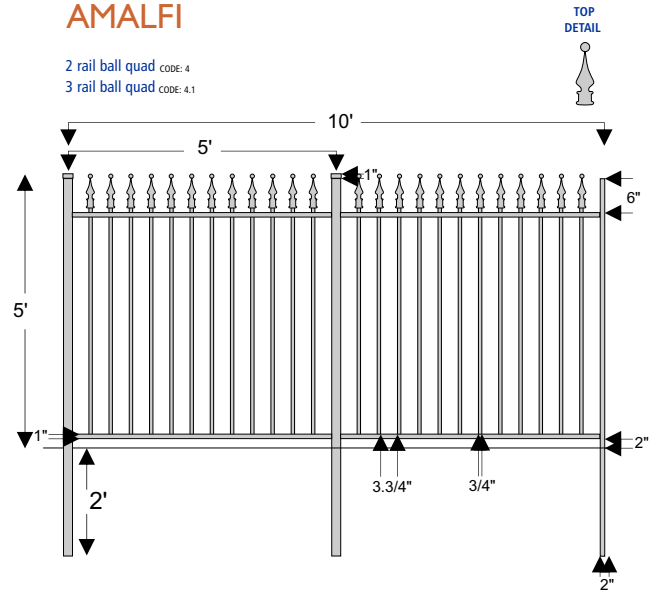

PESCARA

2 rail CODE: 6

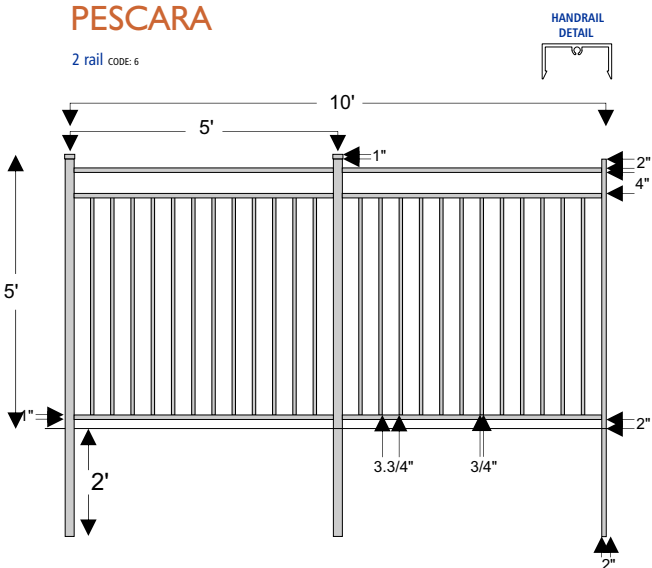

PESCARA SPECIAL

3 rail CODE: 6.1

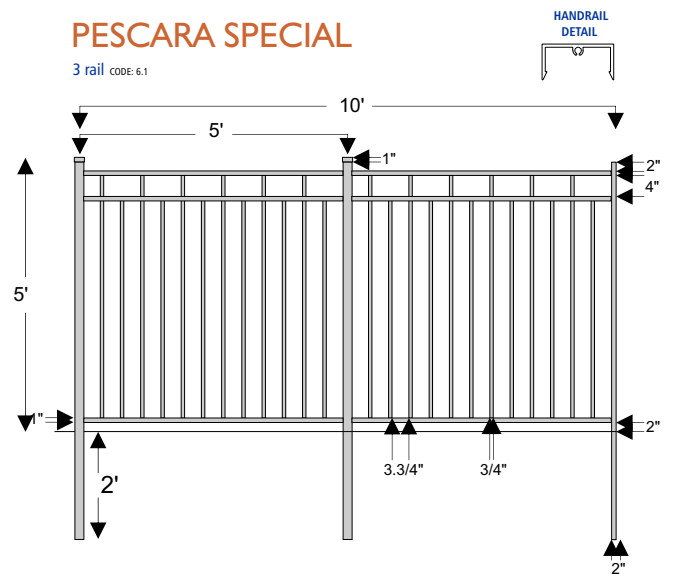

Models

FIRENZE

2 rail CODE: 2
3 rail CODE: 2.1

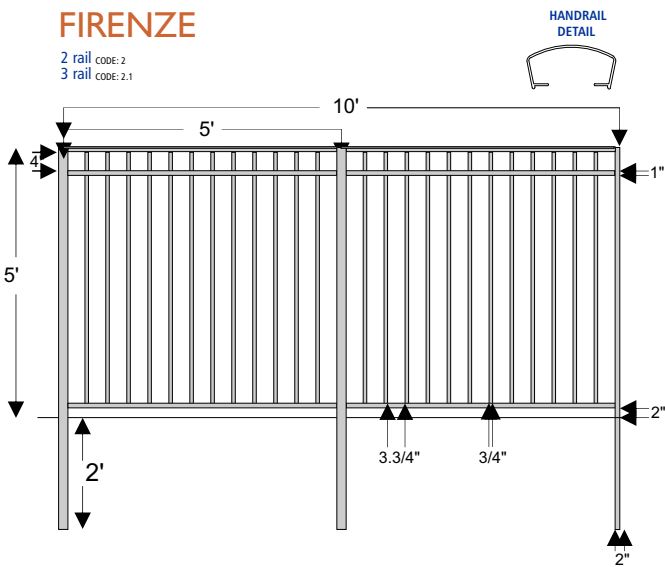

ROMA

2 rail triad CODE: 5
3 rail triad CODE: 5.1

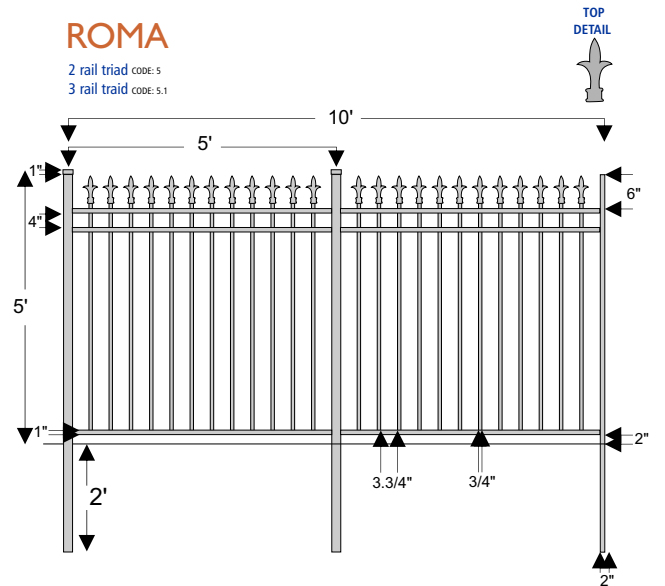

VERONA

2 rail CODE: 8
3 rail CODE: 8.1

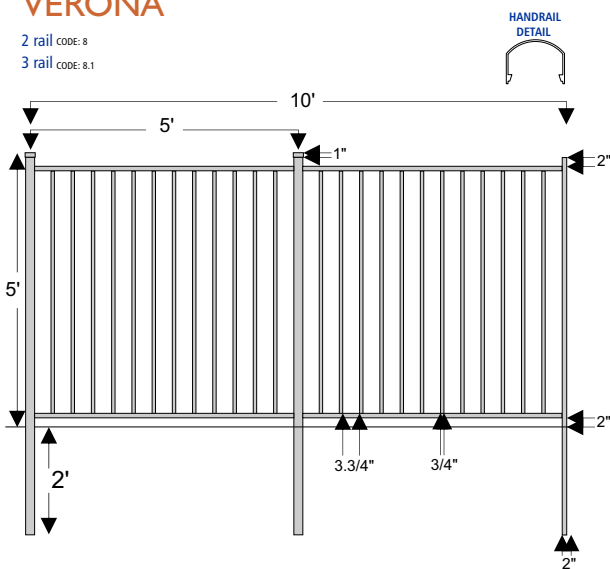

VENEZIA

2 rail lanza CODE: 7
3 rail lanza CODE: 7.1

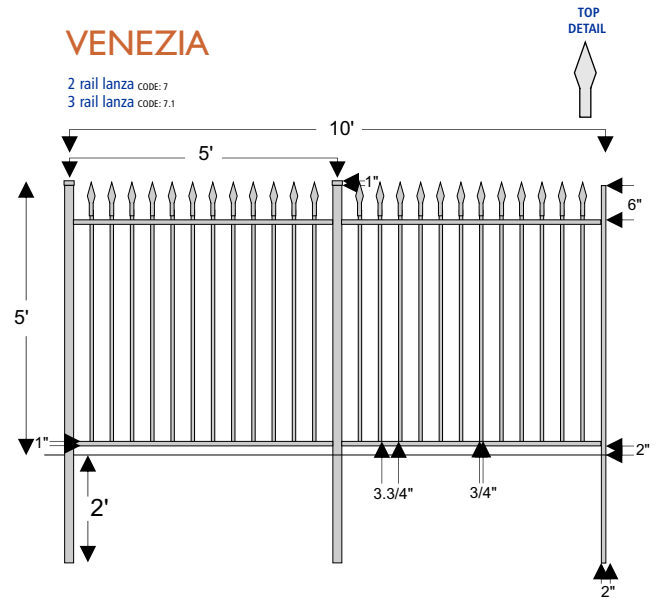



Cladding, Louver and Structures in Aluminum



<https://fencedesignmiami.com/>



A PRODUCT MADE WITH QUALITY
